

Compact Non-contact Door Switch

D40Z

Wide range of applications
at the highest safety level



» Visible safety

» Ultimate safety level

» Versatile applications

Compliant with Safety PLe/Category 4 (ISO 13849-1)

The compact non-contact feature allows easier installation for a wide range of environments.

The D40Z can be used in work environments under any risk level.
Its combination with safety controllers allows for a wide range of applications.

Electromagnetic Induction Method



Actual Size

<D40Z>

Mounts on Either Side

Operating distance
(ON → OFF) :
15 mm max.

Safety Categories

Different types of machines will have different levels of associated risk. As an index for determining the function to secure safety (safety function) based on the risk evaluation, the ISO 13849-1 which stipulates safety-related parts of control systems, categorizes the capability to maintain safety functions in the event of control system failures as category B to 4.

Performance Level (PL)

An index of the safety control system performance level shared by a person who implements risk assessment and a person who designs a machine is called Performance Level (hereinafter abbreviated as "PL") and has 5 levels of evaluation from "a" to "e".

For details on safety category and PL, refer to page 5.

High level of safety for a wide range of applications

ISO 13849-1 (PLe/Safety Category 4) achieved with Non-contact Door Switches

• Self-diagnostic Function

OMRON's unique electromagnetic induction system for safety was achieved by implementing a detection function for external wiring errors in the Switch.

• Redundant internal circuits

The thorough pursuit of safety is evident in mutual checking by double CPUs.

Series connections

• Up to 30 Switches can be connected to one Controller while maintaining PLe/safety category 4.

The D40Z can be connected to G9SP or G9SX-NS Safety Controllers. Select the best model for your application.

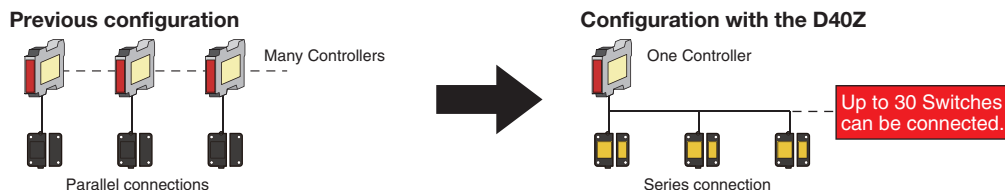

Note 1 : The G9SP supports 2 channels of 15 units each. For more information, refer to *Applicable level and the number of connections according to controller combination* on page 5.

Note 2 : Refer to page 16 for details on safety categories (ISO 13849-1).

How PLe/safety category 4 was achieved with series connections

• Safety software monitoring and diagnosis to detect failures (not possible with series connections of mechanical switches)

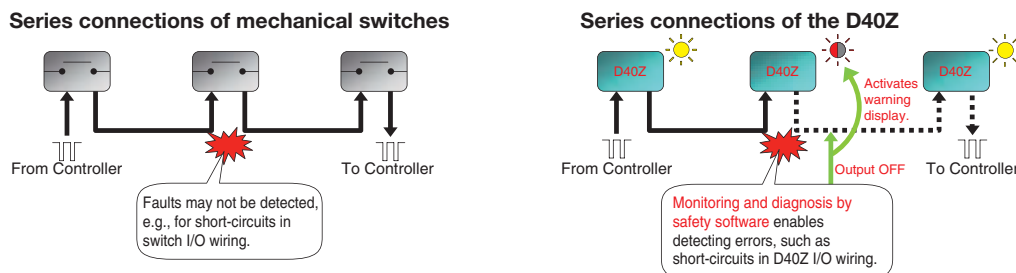

Electromagnetic induction method

• Enables stable detection

With these electronic switches, stable detection is possible even when the door closes slowly.

• No adhesion of iron particles

Permanent magnets are not used, so iron is not attracted, making maintenance easier.

Visible safety

Checking at the production site

The switch's LED indication patterns make identification of abnormal condition possible at the production sites.

Note: For more information, refer to page 10.



- Yellow LED ON : Door closed (normal)
- Yellow LED Blinking : When connected in series; Other D40Zs are turned OFF etc.
- Red LED ON : Door Open
- Red LED Blinking: Error occurred

Centralized monitoring

Bipolar NPN/PNP allows for easy connection with any PLC. The error location can be easily identified. Using a branch relay for a different pole is not required.

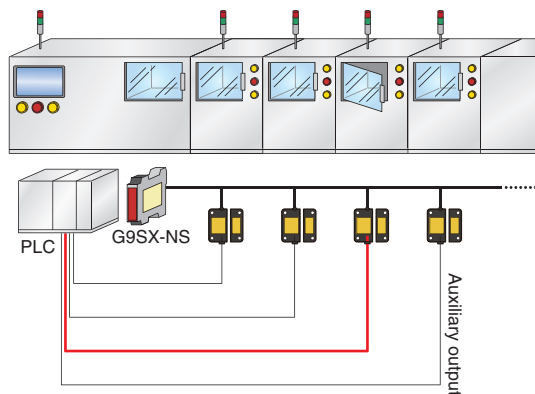

For an easier and safer work environment in all industries. The application of the D40Z will continue to increase in all environments.



Automotive manufacturing (multi-axis robot)

Position detection of a robot (hazard)

Problem

Detecting the position of a multi-axis robot is difficult using a limit switch. Additionally, it is easy to disable the function.

Solution

The non-contact door switch enables ease in detecting the robot position which prevents the operator from easily disabling the function. The maintenance work is safer than ever as the switch conforms to ISO 13849-1 (PLe/safety category 4).

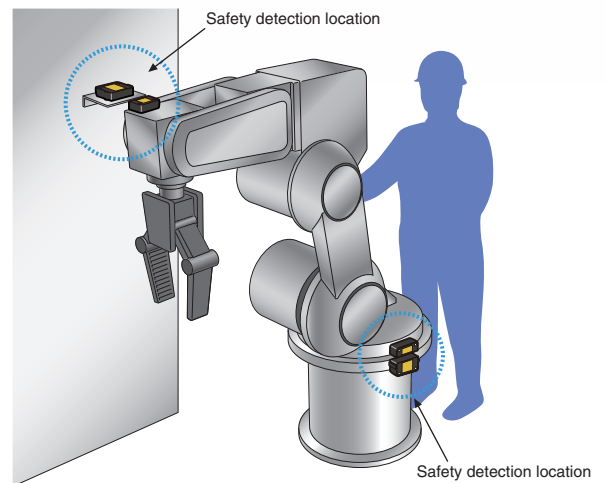

Key factor | **Wide detection area**
ISO 13849-1 (PLe/Safety Category 4)

D40Z



FPD

Manufacturing process

Problem

There are too many doors, and it takes too long to identify the location of a failure when it occurs.

Solution

Auxiliary output is provided for each switch. As each switch can be monitored, it is possible to pinpoint the location of the failure.

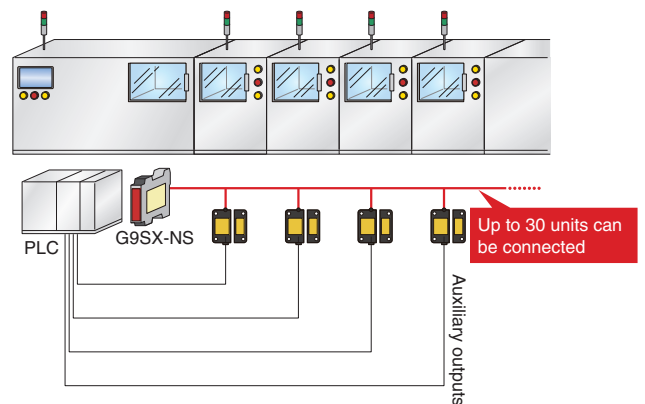

Key factor | **PNP/NPN**
Up to 30 units connectable

Other Application Examples
Equipment for long production lines

D40Z

The D40Z solves problems at the production sites of various industries that require safety (FPD, automotive parts, food, packaging, multi-axis robot, etc).

The D40Z supports a wide range of risk levels, contributing to a safer environment at production sites for various industries' applications.

	<h3>Food</h3>	<h3>Material processing</h3>
	<h4>Problem</h4>	<p>The machine's small size limits the space available to install a switch.</p>
<h4>Solution</h4>	<p>The D40Z's compact size fits into a narrow space (Switch: 48x48x25 mm, Actuator: 48x48x17 mm). The D40Z can be used at an ambient operating temperature of up to 65°C.</p>	
<h4>Key factor</h4>	<p>Compact size Improvement on ambient operating temperature</p>	

 D40Z

	<h3>Automotive parts</h3>	<h3>Manufacturing process for secondary batteries</h3>
	<h4>Problem</h4>	<p>Although safety is ensured with a contact door switch, particles are generated which affect product quality.</p>
<h4>Solution</h4>	<p>With the non-contact door switch D40Z, no particles will be generated through friction.</p>	
<h4>Key factor</h4>	<p>No particles generation</p>	

Other Application Examples
Cleanrooms

 D40Z

A wide range of choices for the versatile applications

A combination of non-contact door switches and safety controllers can be selected according to the application or the required risk level.

Mounting compatibility with the D40A allows for standardization of machine design.

Non-contact Door Switch ■ **Applicable level and the number of connections according to controller combination**

PL/
Safety
Category

PLe/4



Combination	Safety Category	PL (maximum value)	Number of connectable D40Z Series
G9SP + D40Z	4	PLe	15 x 2 channels*
G9SX-NS + D40Z	4	PLe	30
G9SX-NSA + D40Z	4	PLe	30

PLd/3



Combination	Safety Category	PL (maximum value)	Number of connectable D40A Series
G9SP + D40A	3	PLd	15 x 2 channels*
G9SX-NS + D40A	3	PLd	30
G9SX-NSA + D40A	3	PLd	30

* G9SP-N10S supports 15 x 1 channel.

Safety Controller G9SP

- Combine function blocks for flexible programming
- Extensive system configurations
- Decreased work hours by convenient configurator

Function blocks



G9SP Series Catalog
Catalog No.: J181

Non-contact Door Switch Controller G9SX-NS

- Easy expansion of output points with an expansion unit
- Improved maintainability with LED display
- No special programming required



D40A/G9SX-NS Catalog
Catalog No.: C140

Compact non-contact Door Switch D40Z

**Supports ISO 13849-1 (PLe/Safety Category 4).
Can be used on higher risk level applications
by connecting to Safety Controllers.**

- Supports a wide range of applications in combination with Safety Controller G9SP or Non-contact Door Switch Controller G9SX-NS□.
- Up to 30 units can be connected.
Ideal for middle to large scale device applications.
- Contributes to shortening the time it takes to find the cause of failure by the switch's LED display patterns.
- Photocoupler monitor output allows connection to a general-purpose PLC (NPN type).
- Compatibility with the D40A allows standardization of machine design.
- Compact Non-contact Door Switch can be mounted from both sides.

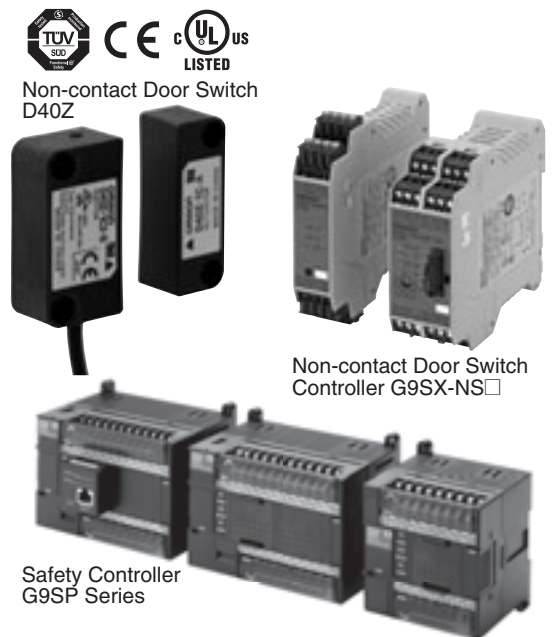

For the most recent information on models that have been certified for safety standards, refer to your OMRON website.

 Refer to "Safety Precautions" on page 14

Model Number Structure

Model Number Legend

Non-contact Door Switch (Switch/Actuator)

D40Z-□□□
1 2 3

1 Type

1: Standard model (Switch/Actuator)

2 Auxiliary Output

C: 1 NO (Photocoupler Output)

3 Cable length

2: 2 m

5: 5 m

Note: Must be used in combination with a G9SP Safety Controller or G9SX-NS□ Non-contact Door Switch Controller. For details, refer to G9SP Series Catalog (Cat.No.J181) or D40A/G9SX-NS Catalog (Cat.No.C140).

D40Z

Ordering Information

Non-contact Door Switch

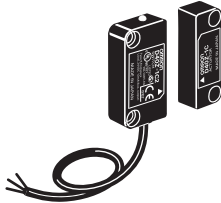
Classification	Appearance	Auxiliary monitoring output	Cable length	Model
Standard models		Photocoupler outputs *1	2 m	D40Z-1C2
			5 m	D40Z-1C5

Note: Must be used in combination with a G9SP Safety Controller or a G9SX-NS□ Non-contact Door Switch Controller.

*1. Photocoupler output. Load current: 10 mA

Non-contact Door Switch Controller G9SX-NS□

Safety outputs *1		Auxiliary monitoring output *3	Logical AND connection input	Logical AND connection output	OFF-delayed Max. OFF-delay time *4	Rated voltage	Terminal block type	Model
Instantaneous	OFF-delayed *2							
2 (Semiconductors)	0	2 (Semiconductors)	1	1	--	24 VDC	Screw terminals	G9SX-NS202-RT
							Spring-cage terminals	G9SX-NS202-RC
	2 (Semiconductors)				3.0 s		Screw terminals	G9SX-NSA222-T03-RT
							Spring-cage terminals	G9SX-NSA222-T03-RC

Note: For details, refer to the D40A/G9SX-NS Catalog (C140).

*1. P channel MOS FET transistor output

*2. The OFF-delayed output becomes an instantaneous output by setting the OFF-delay time to 0 s.

*3. PNP transistor output

*4. The OFF-delay time can be set in 16 steps as follows:

0/0.2/0.3/0.4/0.5/0.6/0.7/0.8/0.9/1.0/1.2/1.4/1.8/2.0/2.5/3.0 s

Safety Controller G9SP Series

Name	No. of I/O points				Unit version	Model
	Safety inputs	Test outputs	Safety outputs	Standard outputs		
Safety Controller	10	4	Semiconductor outputs: 4	4	Ver.2.0	G9SP-N10S
	10	6	Semiconductor outputs: 16	--		G9SP-N10D
	20	6	Semiconductor outputs: 8	--		G9SP-N20S

Note: For details, refer to the G9SP Catalog (F090).

Specifications

Ratings and Characteristics (Non-contact Door Switch)

Item	Model	D40Z-1C□
Operating characteristics	Operating distance (OFF → ON)	5 mm min. *1
	Operating distance (ON → OFF)	15 mm max. *1
	Differential travel	20% or less of operating distance at 23 °C (maximum 2.5mm)
	Influence of temperature	20% or less of operating distance at 23 °C within temperature range of -10 to 65 °C
	Repeat accuracy	±10% of operating distance at 23 °C
	Response time (ON → OFF) *2	25 ms max.
	Operating time (OFF → ON) *2	100 ms max. (Distance between the switch and actuator is 5 mm)
Ambient operating temperature		-10 to 65 °C (with no icing or condensation)
Ambient operating humidity		25% to 85%
Insulation resistance (between charged parts and case)		50 MΩ max. (at 500 VDC)
Dielectric strength (between charged parts and case)		1,000 VAC for 1 min
Degree of contamination		3
Electromagnetic compatibility		IEC/EN 60497-5-3 compliant
Vibration resistance		10 to 55 to 10 Hz (single amplitude: 0.75 mm, double amplitude: 1.5 mm)
Shock resistance		300 m/s ² min.
Degree of protection		IP67
Material		PBT resin
Mounting method		M4 screws
Terminal screw tightening torque		1 N·m
Power supply voltage		24 V DC +10%/-15%
Power consumption *3		0.5 W max.
Auxiliary monitoring output		Photocoupler output: 24 V DC, load current: 10 mA
LED indicators		Actuator not detected (lights in red); error occurred (blinks in red), actuator detected (lights in yellow), actuator detected and Non-contact Door Switch input OFF (blinks in yellow)
Connecting cables		2 m, 5 m
Number of connectable switches *4		30 max. (wiring length: 100 m max.)
Weight		Switch: approx. 175 g, actuator: approx. 20 g (D40Z-1C5)

*1. This is the distance where the switch operates from OFF to ON when approaching and the distance where the switch operates from ON to OFF when separating when the switch and actuator target marks are on the same axis, and the sensing surface coincide. For details, refer to "Engineering Data" on page 9.

*2. Indicates the value of the non-contact door switch output.

*3. Power to be provided to the load is not included.

*4. For details, refer to item "Precautions for Correct Use".

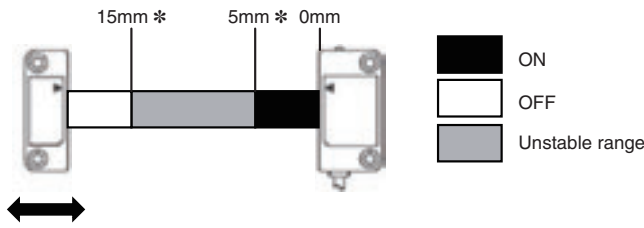

* When the switch and actuator target marks are on the same axis, and the sensing surfaces coincide.

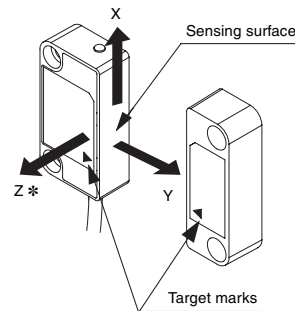
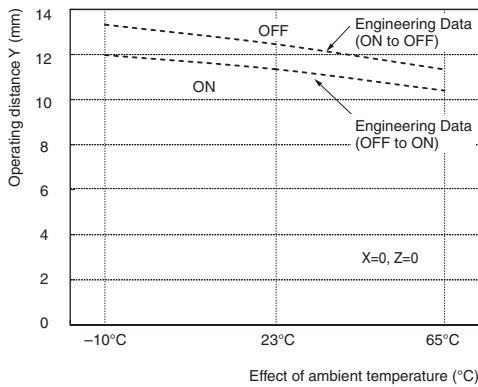
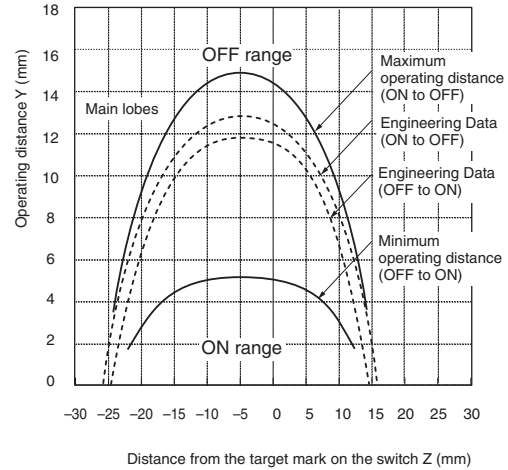
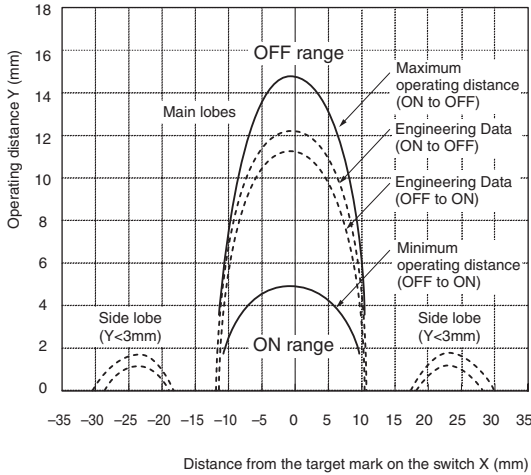

* The movement of the arrow direction indicates the positive direction on the graph.

- Note:**
1. The operating distance is the distance between the switch and actuator sensing surfaces.
 2. Data in the diagram is typical data at an ambient temperature of 23. Actual operating values may vary. The operating distance may be affected by ambient metal, magnet catches, and temperature.
 3. Detection may occur other than on the detection surfaces of the switch and actuator. Before you use the switch and actuator, refer to "Switch and Actuator Operation" on page 17 to set the detection surfaces of the switch and actuator face to face.

Connections

Internal Connection

D40Z-1C□

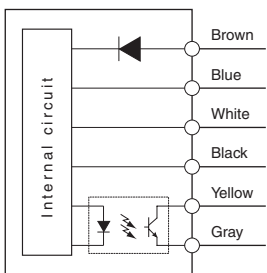

Troubleshooting

LED indicator	Causes and corrective actions *1	
● OFF	Fault in power supply input (brown/blue)	Power supply input may be improperly wired. Check and correct wiring of brown and blue lines. Refer to "Wiring of Inputs and Outputs" on page 11.
		Power supply voltage to D40Z may be insufficient. Check the power supply voltage (between brown and blue lines) of D40Z fills ratings. Refer to "Specifications" on page 8.
		The wiring length or size of the wire may not be to the specification. Check the wiring length and size of the wire. Refer to "Precautions for Correct Use".
☀ Red continuously blinking	Noise or D40Z failure	There may be excessive noise. Check and correct ambient noise environment. There may be a failure in internal circuit. Replace with a new D40Z.
	Fault in power supply input (brown/blue)	Power supply voltage to D40Z may be insufficient. Check the power supply voltage (between brown and blue cables) of D40Z fills ratings. Refer to "Specifications" on page 8. The wiring length or size of the wire may not be to the specification. Check the wiring length and size of the wire. Refer to "Precautions for Correct Use".
☀ Red blinks once for 2s	Fault in Non-contact door switch output (black)	Black line may be shorted to other line. Check and correct wiring of black line if the black line is shorted to other lines. Refer to "Wiring of Inputs and Outputs" on page 11.
☀ Red blinks twice for 2s	Sensing fault	Invalid actuator may be in a close range to switch. Use the dedicated actuator.
☀ Red blinks thrice for 2s	Fault in Non-contact door switch input (white)	Faulty signal may be input to white line. Check and correct wiring of white line. Refer to "Wiring of Inputs and Outputs" on page 11.
☀ Yellow blinking	OFF state of another D40Z	Another D40Z may be in OFF state. Check status of another D40Z connected to the white line and the wiring. Refer to "Switch and Actuator Operation" on page 17 or "Wiring of Inputs and Outputs" on page 11.
	Fault in Non-contact door switch input (white)	White line may be disconnected. Check and correct wiring of white line. Refer to "Wiring of Inputs and Outputs" on page 11.
○ Red Solid-ON #2	Actuator fault	There may be a failure in actuator. Replace with a new D40Z.
○ Yellow Solid-ON #3	Fault in Non-contact door switch input (white)	White line connected to D1 terminal (test output terminal of G9SP) of G9SX-NS□ may be shorted to other line. Check and correct wiring of white line connected to D1 terminal (test output terminal of G9SP) of G9SX-NS□ if the white line is shorted to other lines. Refer to "Wiring of Inputs and Outputs" on page 11.
	Fault in Non-contact door switch output (black)	Black line connected to D2 terminal (safety input terminal of G9SP) of G9SX-NS□ may be disconnected. Check and correct wiring of black line connected to D2 terminal (safety input terminal of G9SP) of G9SX-NS□. Refer to "Wiring of Inputs and Outputs" on page 11.

*1. Another possible cause is a failure in internal circuit. In this case, replace with a new D40Z.

Yet another possible cause is excessive noise. In this case, check and correct ambient noise environment.

*2. Troubleshooting when the actuator is not detected (Red Solid-ON) although the guard door is closed.

*3. Troubleshooting when the system stops although the guard door is closed and the actuator is detected (Yellow Solid-ON).

Non-contact Door Switch

D40Z-1C2

D40Z-1C5

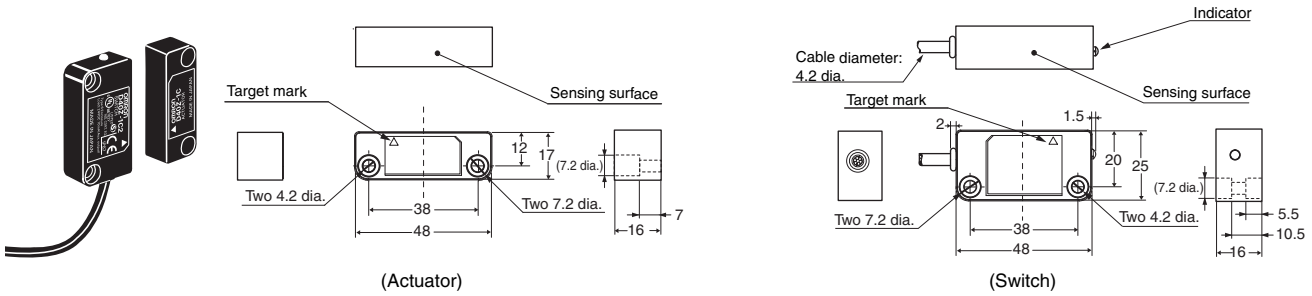

Non-contact Door Switch D40Z and Non-contact Door Switch Controller G9SX-NS□ or Safety Controller G9SP Wiring

Example of connection to G9SX-NS□ (Single connection)

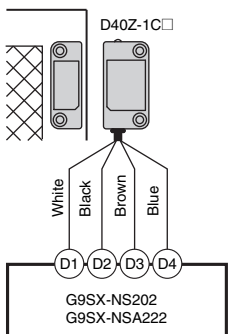

Example of connection to multiple switches

Connect up to 30 Non-contact Door Switches.

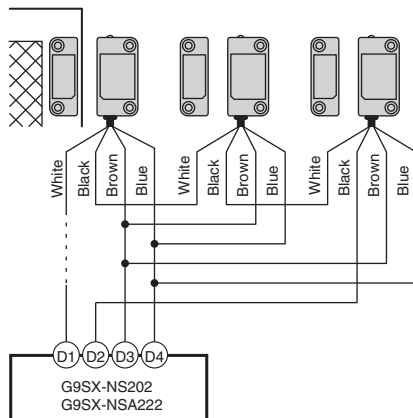

Example of auxiliary outputs

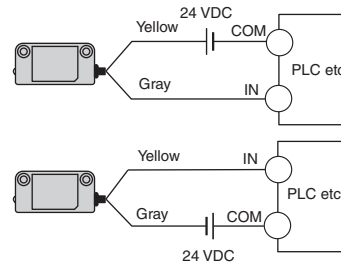

Note: The auxiliary output load current must be 10 mA max.
Wrong connection may lead to a failure of the auxiliary output circuit.

Wiring of Inputs and Outputs

Signal name		Cable color	Description of operation
Non-contact Door Switch power supply input	+	Brown	Supplies power to the D40Z.
	-	Blue	
Non-contact door switch input		White	To set non-contact door switch output in ON state, non-contact door switch signal input must be in ON state.
Non-contact door switch output		Black	Output status depends on statuses of actuator and non-contact door switch signal input.
Auxiliary monitoring output		Yellow	Output status depends on status of actuator. When a fault is detected, turns into OFF state regardless of actuator status.
		Gray	

Application Examples

G9SP-N20S(24 VDC) (2-channel Emergency Stop Switch Inputs + Non-contact Door Switch/Manual Reset)

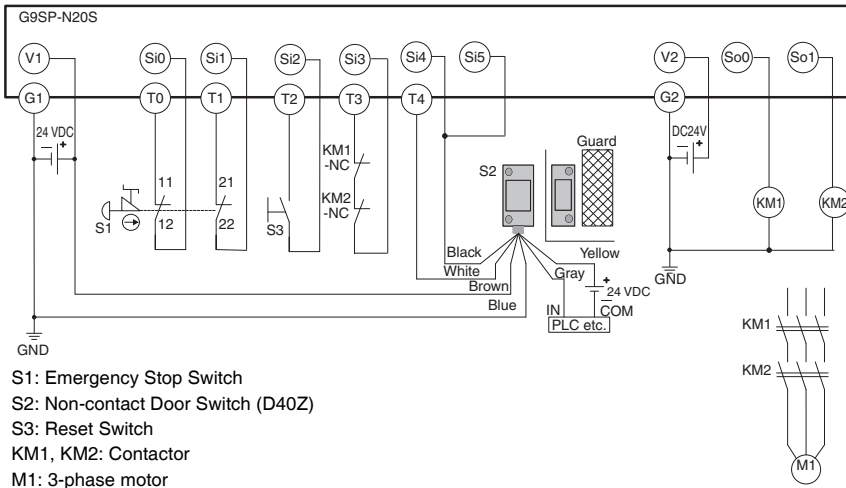

- S1: Emergency Stop Switch
- S2: Non-contact Door Switch (D40Z)
- S3: Reset Switch
- KM1, KM2: Contactor
- M1: 3-phase motor

- Note:**
1. The PL and category that correspond to this circuit example vary depending on the program configured to the G9SP-N20S. For details, refer to "G9SP Series User's Manual (Cat.No.Z922)".
 2. For details on terminal arrangement, refer to "G9SP Series User's Manual (Cat.No.Z922)".
 3. Wire auxiliary outputs correctly. Incorrect wiring may lead to a failure of the auxiliary output circuit.

G9SX-NSA222-T03-□ (24 VDC) (2-channel Emergency Stop Switch Inputs + Non-contact Door Switch/Manual Reset)

PL/safety category	Model	Stop category	Reset
PLe/4 equivalent	Non-contact Door Switch D40Z Non-contact Door Switch Controller G9SX-NSA222-T03-□ (24 VDC)	1	Manual

- Note:**
1. The above PL is only the evaluation result of the example. The PL must be evaluated in an actual application by the customer after confirming the usage conditions.
 2. The above PL is the evaluation result concerning the guard. The PL for emergency stop switch and other safety functions must be separately evaluated.
 3. Stopping time is required between when an opening of the guard is detected and when the motor M stops. Use after risk assessment to prevent operators from approaching hazardous areas too closely during this period.

Application Overview

- The S2 monitors the guard, and stop command is sent to the motor controller when the guard is opened.
- The power supply to the motor M is turned OFF after OFF-delay time.
- The power supply to the motor M is kept OFF while the guard is opened.
- The power supply to the motor M is turned ON again when the reset switch S3 is pressed while the guard is closed.

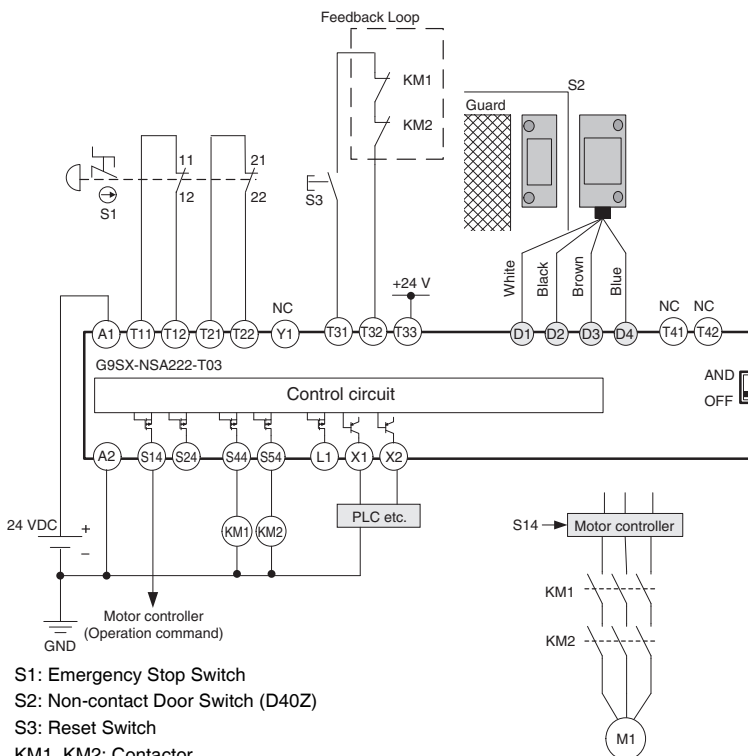

- S1: Emergency Stop Switch
- S2: Non-contact Door Switch (D40Z)
- S3: Reset Switch
- KM1, KM2: Contactor
- M1: 3-phase motor

Note: For details, refer to "Safety Category (ISO 13849-1)" on page 17.

Timing chart

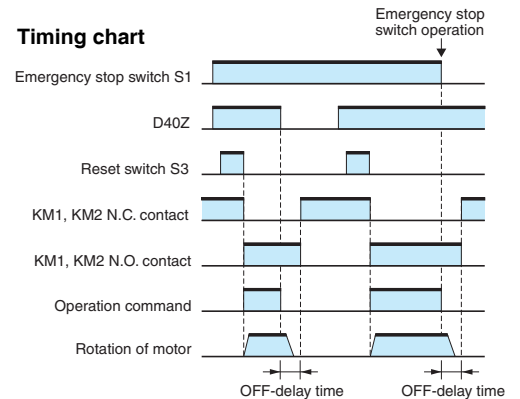

G9SX-BC202 (24 VDC) (2-channel Emergency Stop Switch Inputs/Manual Reset) + G9SX-NS202-□ (24 VDC) (Non-contact Door Switch/Auto Reset)

PL/safety category	Model	Stop category	Reset
PL _e /4 equivalent	Non-contact Door Switch D40Z Non-contact Door Switch Controller G9SX-NSA222-T03-□ (24 VDC)	0	Auto

Note: 1. The above PL is only the evaluation result of the example. The PL must be evaluated in an actual application by the customer after confirming the usage conditions.
2. The above PL is the evaluation result concerning the guard. The PL for emergency stop switch and other safety functions must be separately evaluated.

Application Overview

- The S3 monitors the guard, and the power supply to the motor M2 is turned OFF immediately when the guard is opened.
- The power supply to the motor M2 is kept OFF while the guard is opened.
- The power supply to the motor M2 is turned ON again when the guard is closed.

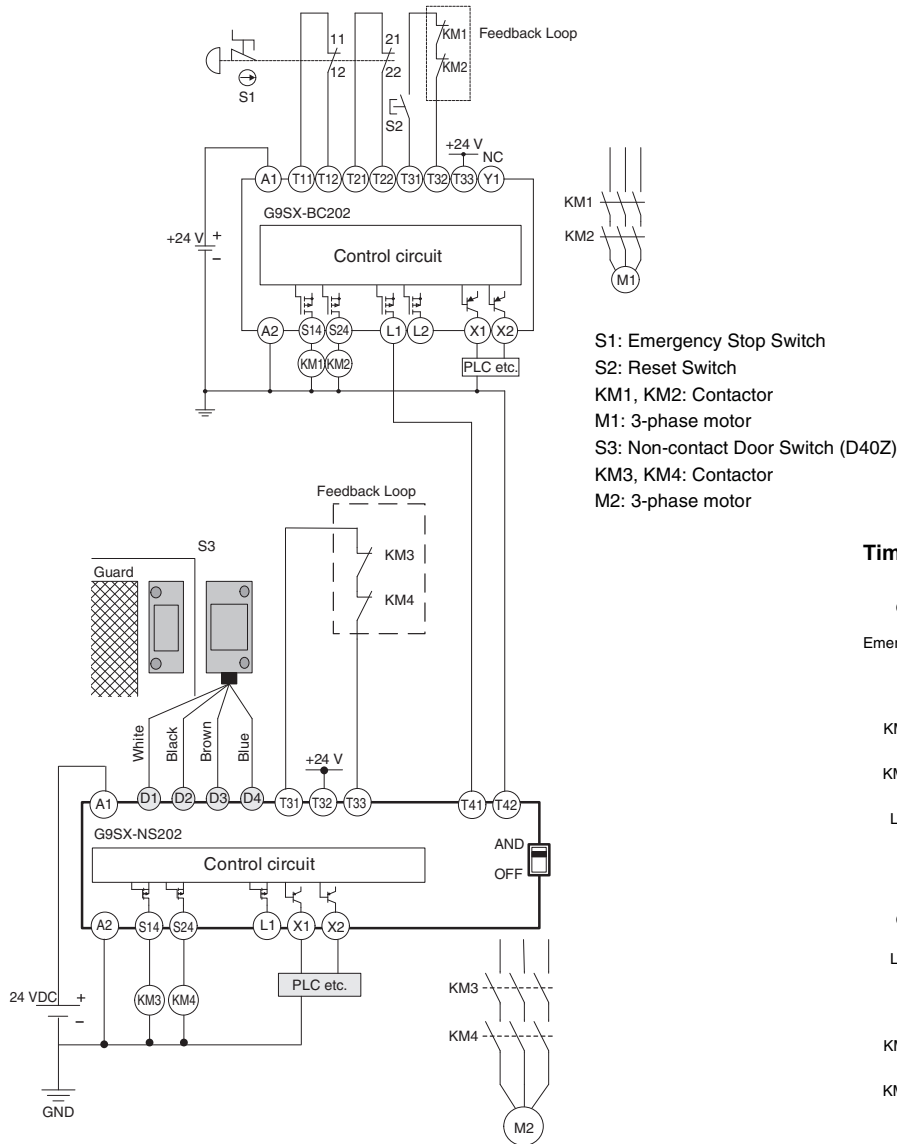

Timing chart

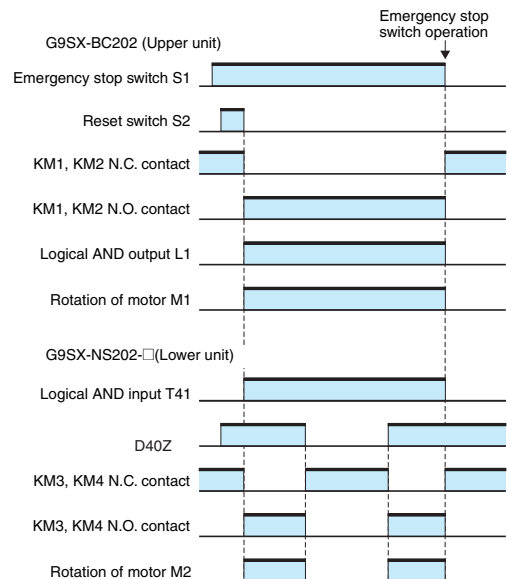

Note: For details, refer to "Safety Category (ISO 13849-1)" on page 16

Safety Precautions

Be sure to read the precautions for **All Safety Door Switches** in the website at:<http://www.ia.omron.com/>.

Indication and Meaning for Safe Use

 WARNING	Indicates a potentially hazardous situation which, if not avoided, will result in minor or moderate injury, or may result in serious injury or death. Additionally there may be significant property damage.
Precautions for Safe Use	Supplementary comments on what to do or avoid doing, to use the product safely.
Precautions for Correct Use	Supplementary comments on what to do or avoid doing, to prevent failure to operate, or undesirable effect on product performance.

 **WARNING**

Serious injury may possibly occur due to breakdown of safety outputs.
Do not connect loads beyond the rated value to the safety outputs.



Serious injury may possibly occur due to loss of required safety functions.
Wire the Edge Controller properly so that supply voltages or voltages for loads do NOT touch the safety outputs accidentally.



Serious injury may possibly occur due to breakdown of safety outputs.
Apply protection circuitry against back electromotive force in case connecting inductive loads to safety outputs.



Serious injury may possibly occur due to loss of required safety functions.
Use appropriate devices referring to the following table.



The machine may start operating and may result in serious injury or death. Do not put the actuator close to the switch when the door is open.



Control device	Requirements
Emergency Stop Switch	Use approved device with direct opening mechanism complying with IEC/EN 60947-5-1.
Safety Door Switch, Safety Limit Switch	Use approved device with direct opening mechanism complying with IEC/EN 60947-5-1 and capable of switching micro loads of 24 VDC, 5 mA.
Non-contact Door Switch	The G9SX-NS must be used with D40Z Non-contact Door Switches.
Relay with forcibly guided contacts	Use approved devices with forcibly guided contacts complying with EN 50205. For feedback, use devices with contacts capable of switching micro loads of 24 VDC, 5 mA.
Contactor	Use contactors with forcibly guided mechanism to input the signal to the Feedback/Reset input of the G9SX-NS through the NC contact of the contactor. For feedback, use devices with contacts capable of switching micro loads of 24 VDC, 5 mA. Failure to open contacts of a contactor cannot be detected by connecting NC contact of the contactor without a forcibly guided mechanism to the Feedback/Reset input.
Other devices	Evaluate whether devices used are appropriate to satisfy the requirements of the safety category level.

Precautions for Safe Use

1. Disconnect the G9SX-NS from the power supply when wiring the D40Z. Devices connected to the product may operate unexpectedly.
2. Do not operate the product in atmospheres containing flammable or explosive gas.
3. Wire conductors correctly and verify the operation of the product before using the system in which the product is incorporated. Incorrect wiring may lead to loss of safety functions.
4. Auxiliary monitoring outputs are NOT safety outputs. Do not use auxiliary monitoring outputs as safety outputs. Such incorrect use will cause loss of safety function of D40Z and peripheral devices.
5. After installing the D40Z, qualified personnel must confirm the installation, and must conduct test operations and maintenance. The qualified personnel must be qualified and authorized to secure safety at each phases of design, installation, running, maintenance, and disposal of the system.
6. A qualified person in charge, who is familiar with the machine in which the D40Z is to be installed, must conduct and verify the installation.
7. Be sure to inspect the D40Z daily and every 6 months. Otherwise, serious injury may possibly occur due to system malfunctions.
8. Do not dismantle, repair, or modify the product. Doing so may lead to loss of safety functions.
9. Do not apply DC voltages exceeding the rated voltages, nor any AC voltages to D40Z.
10. Use a DC supply satisfying the requirements given below to prevent electric shock.
 - A DC power supply with double or reinforced insulation, for example, according to IEC/EN 60950 or EN 50178, or a transformer according to IEC/EN 61558.
 - A DC supply satisfying the requirements for class 2 circuits or limited voltage/current circuits stated in UL 508.
11. Connect the D40Z to only appropriate components or devices complying with relevant safety standards corresponding to the required level of safety category. Conformity to requirements of the safety category must be determined for the entire system. It is recommended to consult an authorized certification body regarding assessment of conformity to the required safety level.

Precautions for Correct Use

1. The D40Z must be used with a designated actuator and controller to comply with EN ISO 13849-1.
2. Handle with care
Do not drop the product or expose it to excessive vibration or mechanical shock. The product may be damaged and may not function properly.
3. Storage and operating conditions
Do not store or use the products under the following conditions.
 1. In direct sunlight
 2. At ambient temperatures not between -10 and 65°C
 3. At relative humidity not between 25% and 85%
 4. In corrosive or combustible gases
 5. Where subject to vibration or mechanical shock beyond the rated values
 6. Where subject to contact with oil or chemicals
 7. In an atmosphere containing excessive dust, saline, or metal powder
 8. Where iron filings or powder may fall on the product
4. Do not use D40Z at altitudes over 1,000 meters.
5. Do not use to connect other switches or sensors to the wire conductors of D40Z.
6. Disconnect D40Z and the controller connected to D40Z from power supply when replacing D40Z. Failure to do so may cause unexpected operation of devices connected to D40Z.
7. Keep D40Z from solvent such as alcohol, thinner, trichloroethane or gasoline. Such solvents make the marking on D40Z illegible and cause deterioration of parts.
8. Do not use D40Z in the magnetic field of 1.5 mT or more, otherwise D40Z may not function properly.
9. Do not use D40Z in the water or continuous water exposure environment, otherwise water may leak into D40Z. (An enclosure of IP67 rating, which D40Z is rated, protects against temporary immersion in water.)
10. Do not use D40Z switch or actuator as a stopper. Use a stopper to protect the switch and the actuator. Keep a distance of at least 1 mm between the switch and the actuator.
11. Be sure to install D40Z switch and actuator in such as appropriate distance that does not create a gap accessible to the hazard.

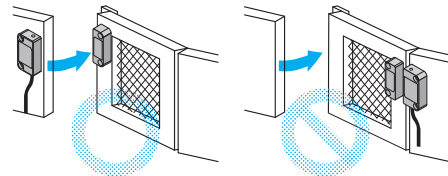

12. When installing two or more adjacent switches, keep a distance of at least 50 mm from one another.

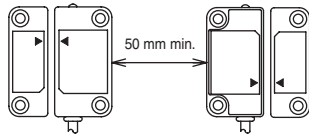

13. Be sure that the machine is stopped whenever the guard door is open.

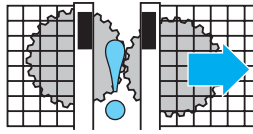

14. Mounting the switch and actuator on metal may affect the operating distance. If there are nearby devices that generate strong radio waves or magnetic fields, they may also affect the operating distance through the metal. Do not mount the switch and actuator directly on metal.

When installing them on a metallic material, be sure to verify such an effect before using. Refer to the following table for the estimated effects of mounting on metal on the operating distance.

Type of metal	Operating distance
Iron	Approx. 75% of normal distance
Aluminum	Approx. 85% of normal distance
Stainless steel	Approx. 85% of normal distance

We recommend that you separate the switch and actuator at least 10 mm from all nearby metal.

15. Use M4 screws with a maximum diameter of 7mm and washers to install the switch and actuator. Tighten the screws with a specified torque. After installing and commissioning, coat the switch-actuator fixing screws with tamper-proof varnish or similar compound for locking. Using anaerobic locking compounds can have a detrimental effect on the plastic switch case if the compounds contact with the switch case.

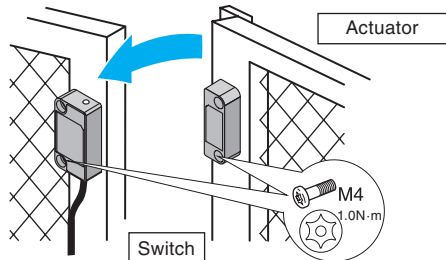

16. Wiring

1. Stranded wire : 0.2 to 2.5 mm AWG24 to AWG12
Solid wire : 0.2 to 2.5 mm AWG24 to AWG12
2. When not using auxiliary output, cut off the unused conductors and protect by insulating-taping to prevent contacting with other terminals.
3. When you use an additional cable of 20 m or longer, use a multiconductor cable to group the white, black, brown, and blue lines together.

17. Use cables of a total length of 100 m max. to connect multiple D40Z switches. However, the total length of 200 m max. is possible depending on the number of D40Z switches connected. The supply voltage to D40Z may decrease by the voltage drop depending on the cable or the wiring configuration. Check the power-supply voltage is in the rated range.

30 or less D40Z connected 15 or less D40Z connected

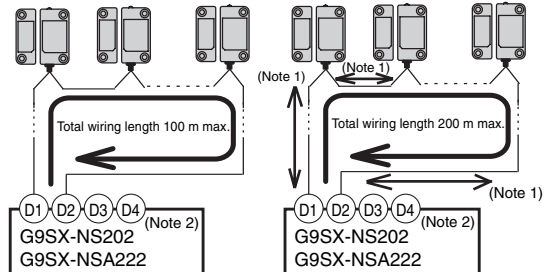

Note 1. The wiring length between the products must be 100 m max.

Note 2. For details on connection terminal and wiring of G9SP, refer to the G9SP Manual (Cat.No.Z922).

18. D40Z is a class A product. In residential areas D40Z may cause radio interference, in which case the user may be required to take adequate measures to reduce interference.
19. D40Z may not function properly in surrounding environment with strong electromagnetic equipment such as RFID system, proximity sensor, motor, inverter, and switching power supply. If you use D40Z near such equipment, be sure to verify effects of such equipment on D40Z before using.
20. Handle cables with care:
1. For bending cables, it is recommended to bend them with a radius of bend no less than six times the cable outer diameter.
 2. Do not apply a tensile strength of 50N or greater to the cables.
21. To determine safety distance to hazards, take into account the delay of non-contact door switch output caused the response time.
22. If there is any machine that has a large surge current (e.g., a motor) near D40Z, connected a surge absorber to D40Z between the blue and the other cables (white, black and brown) respectively, or between the yellow cable and gray cable. Suggested surge absorber's specification is as follows:
- Peak pulse power: 600 W (10/1000 μs) or more (Per IEC 61000-4-5 (surge immunity))
 - Breakdown voltage: 27-33 V

Switch and Actuator Operation

Switch and Actuator Mounting Directions

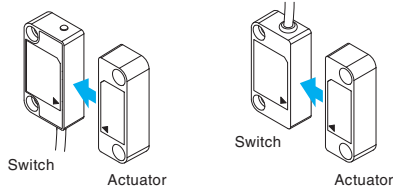

Switch and actuator operating directions

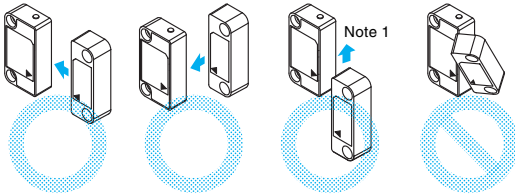

Note 1. When using the operating direction along the sensing surface, be sure to provide a gap of at least 3 mm between the switch and actuator to eliminate the effects of the side lobes.

Safety Category (ISO 13849-1)

When used in combination with the G9SP or G9SX-NS□, the D40Z can be used for the environments corresponding to performance level e and safety category 4 as required by EN ISO 13849-1.

The settings are determined by circuit examples provided by OMRON, however, and may not be applicable depending on the operating conditions. Performance levels and safety categories are determined for the safety control system as a whole. You must confirm conformity for the entire system.

Approved Standards

- EN ISO 13849-1: 2008 PL_e/Safety Category 4 (used with G9SX-NS□)
- IEC/EN 61508 SIL 3 (used with G9SX-NS□)
- IEC/EN 60947-5-3 PDF-M (used with G9SX-NS□)
- UL 508
- CAN/CSA C22.2 No.14

READ AND UNDERSTAND THIS CATALOG

Please read and understand this catalog before purchasing the products. Please consult your OMRON representative if you have any questions or comments.

Warranty and Limitations of Liability

WARRANTY

OMRON's exclusive warranty is that the products are free from defects in materials and workmanship for a period of one year (or other period if specified) from date of sale by OMRON.

OMRON MAKES NO WARRANTY OR REPRESENTATION, EXPRESS OR IMPLIED, REGARDING NON-INFRINGEMENT, MERCHANTABILITY, OR FITNESS FOR PARTICULAR PURPOSE OF THE PRODUCTS. ANY BUYER OR USER ACKNOWLEDGES THAT THE BUYER OR USER ALONE HAS DETERMINED THAT THE PRODUCTS WILL SUITABLY MEET THE REQUIREMENTS OF THEIR INTENDED USE. OMRON DISCLAIMS ALL OTHER WARRANTIES, EXPRESS OR IMPLIED.

LIMITATIONS OF LIABILITY

OMRON SHALL NOT BE RESPONSIBLE FOR SPECIAL, INDIRECT, OR CONSEQUENTIAL DAMAGES, LOSS OF PROFITS OR COMMERCIAL LOSS IN ANY WAY CONNECTED WITH THE PRODUCTS, WHETHER SUCH CLAIM IS BASED ON CONTRACT, WARRANTY, NEGLIGENCE, OR STRICT LIABILITY.

In no event shall responsibility of OMRON for any act exceed the individual price of the product on which liability is asserted.

IN NO EVENT SHALL OMRON BE RESPONSIBLE FOR WARRANTY, REPAIR, OR OTHER CLAIMS REGARDING THE PRODUCTS UNLESS OMRON'S ANALYSIS CONFIRMS THAT THE PRODUCTS WERE PROPERLY HANDLED, STORED, INSTALLED, AND MAINTAINED AND NOT SUBJECT TO CONTAMINATION, ABUSE, MISUSE, OR INAPPROPRIATE MODIFICATION OR REPAIR.

Application Considerations

SUITABILITY FOR USE

OMRON shall not be responsible for conformity with any standards, codes, or regulations that apply to the combination of products in the customer's application or use of the product.

At the customer's request, OMRON will provide applicable third party certification documents identifying ratings and limitations of use that apply to the products. This information by itself is not sufficient for a complete determination of the suitability of the products in combination with the end product, machine, system, or other application or use.

The following are some examples of applications for which particular attention must be given. This is not intended to be an exhaustive list of all possible uses of the products, nor is it intended to imply that the uses listed may be suitable for the products:

- Outdoor use, uses involving potential chemical contamination or electrical interference, or conditions or uses not described in this document.
- Nuclear energy control systems, combustion systems, railroad systems, aviation systems, medical equipment, amusement machines, vehicles, safety equipment, and installations subject to separate industry or government regulations.
- Systems, machines, and equipment that could present a risk to life or property.

Please know and observe all prohibitions of use applicable to the products.

NEVER USE THE PRODUCTS FOR AN APPLICATION INVOLVING SERIOUS RISK TO LIFE OR PROPERTY WITHOUT ENSURING THAT THE SYSTEM AS A WHOLE HAS BEEN DESIGNED TO ADDRESS THE RISKS, AND THAT THE OMRON PRODUCT IS PROPERLY RATED AND INSTALLED FOR THE INTENDED USE WITHIN THE OVERALL EQUIPMENT OR SYSTEM.

Disclaimers

CHANGE IN SPECIFICATIONS

Product specifications and accessories may be changed at any time based on improvements and other reasons.

It is our practice to change model numbers when published ratings or features are changed, or when significant construction changes are made. However, some specifications of the product may be changed without any notice. When in doubt, special model numbers may be assigned to fix or establish key specifications for your application on your request. Please consult with your OMRON representative at any time to confirm actual specifications of purchased products.

DIMENSIONS AND WEIGHTS

Dimensions and weights are nominal and are not to be used for manufacturing purposes, even when tolerances are shown.

ERRORS AND OMISSIONS

The information in this document has been carefully checked and is believed to be accurate; however, no responsibility is assumed for clerical, typographical, proofreading errors, or omissions.

PERFORMANCE DATA

Performance data given in this catalog is provided as a guide for the user in determining suitability and does not constitute a warranty. It may represent the result of OMRON's test conditions, and the users must correlate it to actual application requirements. Actual performance is subject to the OMRON Warranty and Limitations of Liability.

PROGRAMMABLE PRODUCTS

OMRON shall not be responsible for the user's programming of a programmable product, or any consequence thereof.

Copyright and Copy Permission

COPYRIGHT AND COPY PERMISSION

This document shall not be copied for sales or promotions without permission.

This document is protected by copyright and is intended solely for use in conjunction with the product. Please notify us before copying or reproducing this document in any manner, for any other purpose. If copying or transmitting this document to another, please copy or transmit it in its entirety.

OMRON Corporation Industrial Automation Company
Tokyo, JAPAN

Contact: www.ia.omron.com

Regional Headquarters

OMRON EUROPE B.V.

Wegalaan 67-69-2132 JD Hoofddorp
The Netherlands

Tel: (31)2356-81-300/Fax: (31)2356-81-388

OMRON SCIENTIFIC TECHNOLOGIES INC.

6550 Dumbarton Circle, Fremont
CA 94555-3605 U.S.A.

Tel: (1) 510-608-3400/Fax: (1) 510-744-1442

OMRON ASIA PACIFIC PTE. LTD.

No. 438A Alexandra Road # 05-05/08 (Lobby 2),
Alexandra Technopark,
Singapore 119967

Tel: (65) 6835-3011/Fax: (65) 6835-2711

OMRON (CHINA) CO., LTD.

Room 2211, Bank of China Tower,
200 Yin Cheng Zhong Road,
PuDong New Area, Shanghai, 200120, China

Tel: (86) 21-5037-2222/Fax: (86) 21-5037-2200

Authorized Distributor:

© OMRON Corporation 2010 All Rights Reserved.
In the interest of product improvement,
specifications are subject to change without notice.

CSM_7_3_0116

Cat. No. C145-E1-01

Printed in Japan

0910